

## Product documentation

<b>Product serial number:</b>
<b>KOZV M 175 G</b>

## TECHNICAL DOKUMENTATION

NAME: KOZV M 175 G

<b>TYPES:</b>	unique
<b>USE:</b>	A user-correct M63.80A measurement in grounded, free-standing design
<b>APPLICATION:</b>	outdoor
<b>CONNECTION METHOD:</b>	ground cable
<b>SIZES:</b>	1710 x 583 x 277 mm
<b>LOCATION:</b>	FREE STANDING

### LIST OF MATERIALS:

NAME	PCS	TYPE MARK	COMMENT
CABINET	1	SL 175	10-25mm <sup>2</sup> with inner wiring
MOUNTING SHEET	1	175 P	1 or 3 phase meetering
Csatári 300*300 JUNCTION BOX	1	PVT3030	To receive an immeasurable cable
Csatári JUNCTION BOX	2	CSP 081908	For restrictors
Csatári JUNCTION BOX	2	CSP122209	Above 32A solenoid switch
COVERED BRANCH CLAMP	3	WPE230	for ascending mains phase conductors
connecting block	2	PEN sín	to the PEN head of the take-off main
outgoing terminal block	6	WDU 50mm <sup>2</sup>	To the leader of the outgoing phase with Covering
outgoing terminal block	2	WDU 50mm <sup>2</sup> Kék	Going to the head of N.
outgoing terminal block	2	WPE 50mm <sup>2</sup> Z/s	Going to the head of PE
cable clamp	3	OBO 22-28mm <sup>2</sup>	for securing incoming, outgoing cables
hinge	2	498428	to open the mounting plate
wiring	1	MKH H07V-K 10-25mm <sup>2</sup>	internal wiring sleeve 18mm
gland	1	36	

### NOTES:

Connecting riser main line: 5x16mm<sup>2</sup> - 5x50mm<sup>2</sup>.

Tightening torque for through terminals max: 6 Nm

### MESURED SIDE OPTIONS

Fire protection switch	1	3-4P 20-80A.-ig	DILOS, STILO, ETON, Schneider, Ganz
Surge arrester	1	V50-3+NPE, VAL-MS 230/3+1	OBO, DEHN, Phonix

OUTLINE



RENDSZERENGEDÉLY: KOZV M 175 G MÉRŐSZEKRÉNY

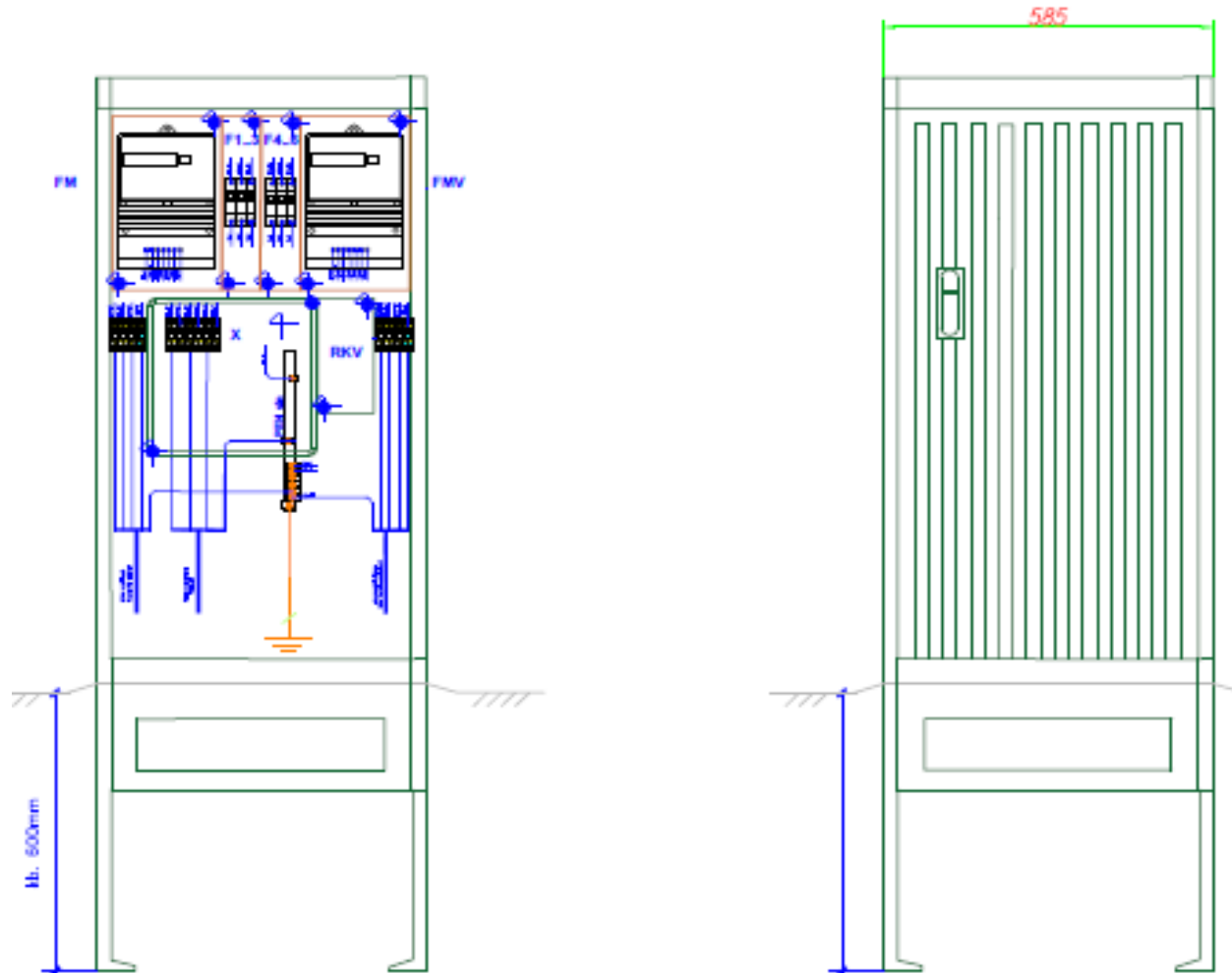

LAYOUT WITH SEALING PLACES

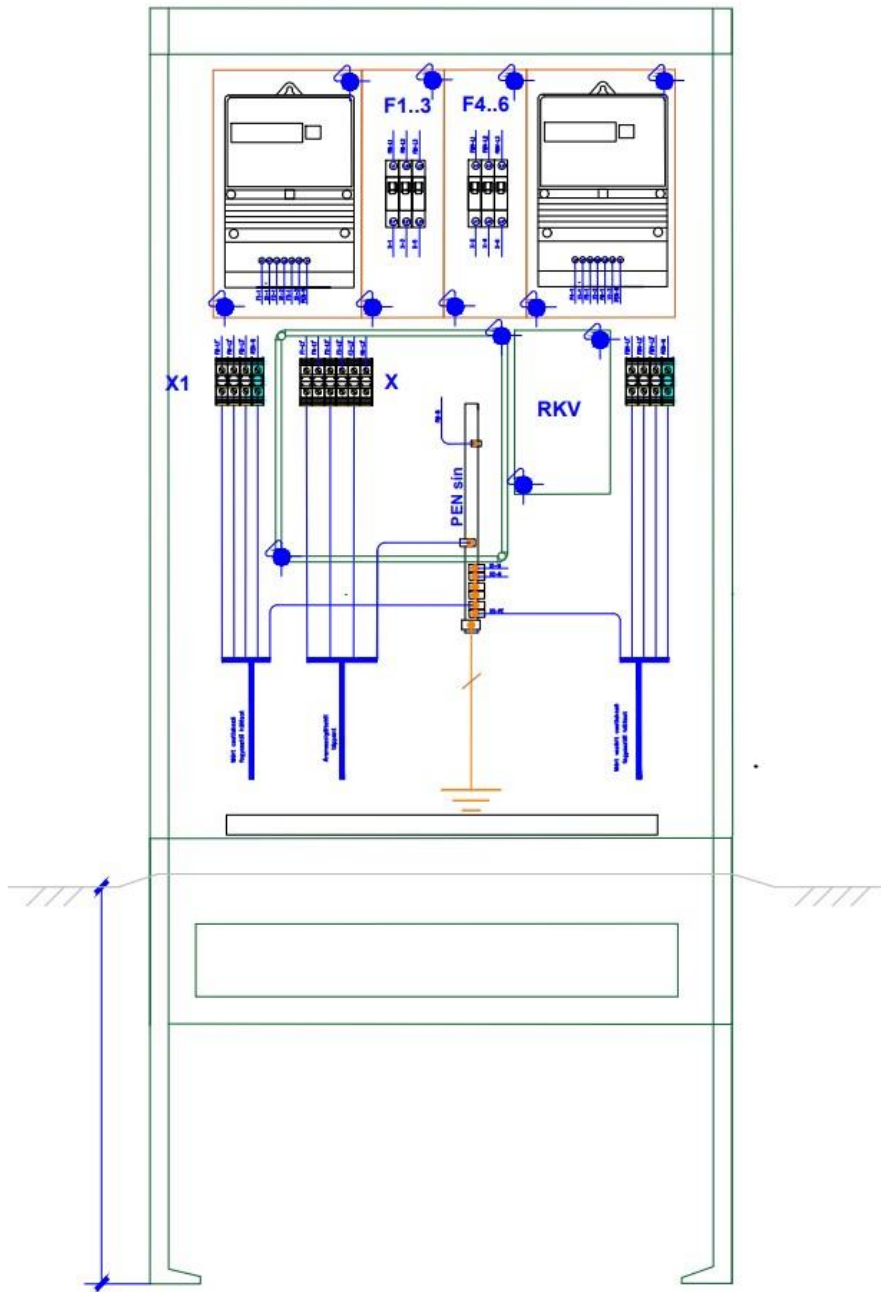

CASE

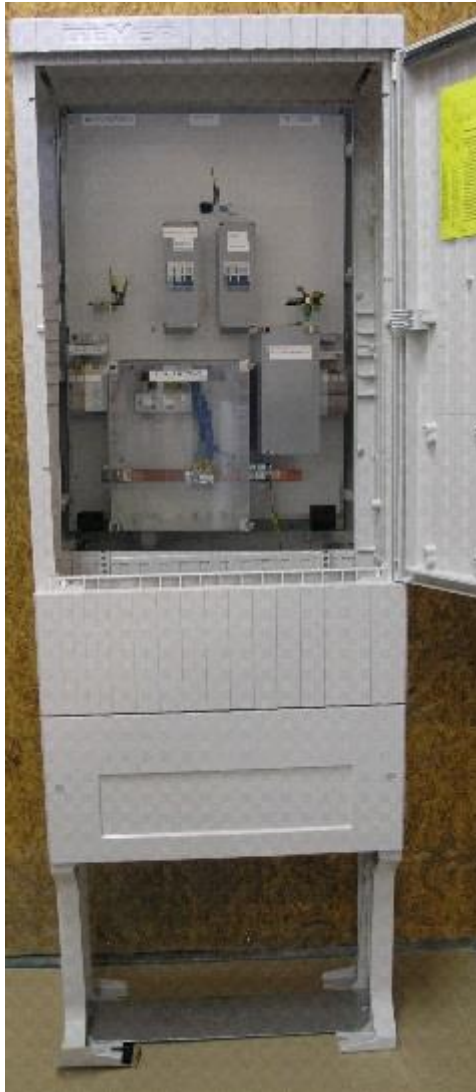

MEASUREMENT AREA



## CONNECTION AREA

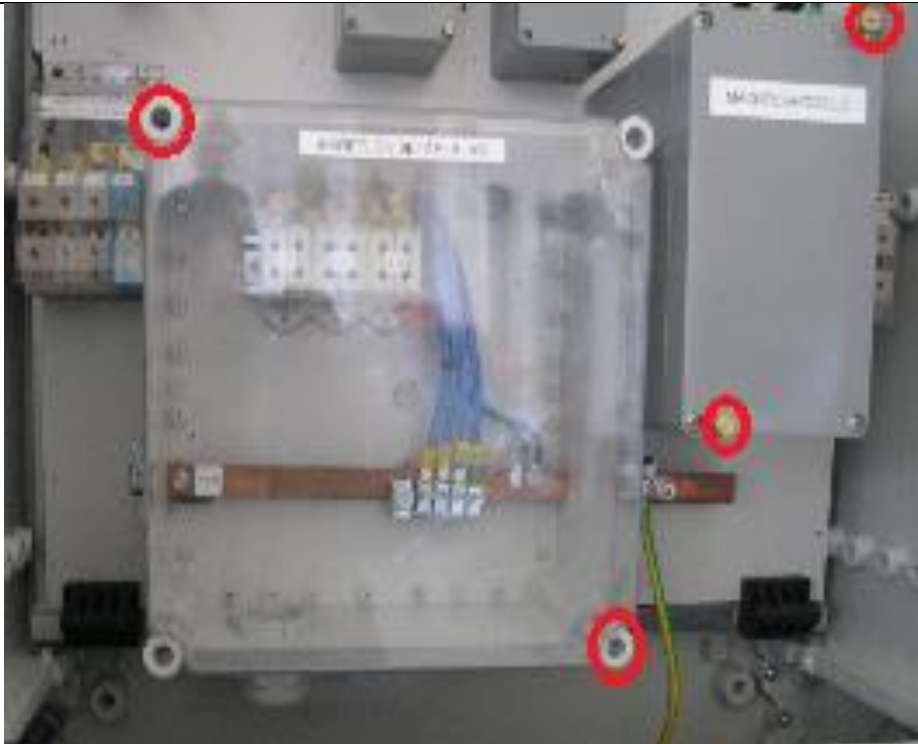



RENDSZERENGEDÉLY: KOZV M 175 IB MÉRŐSZEKRÉNY

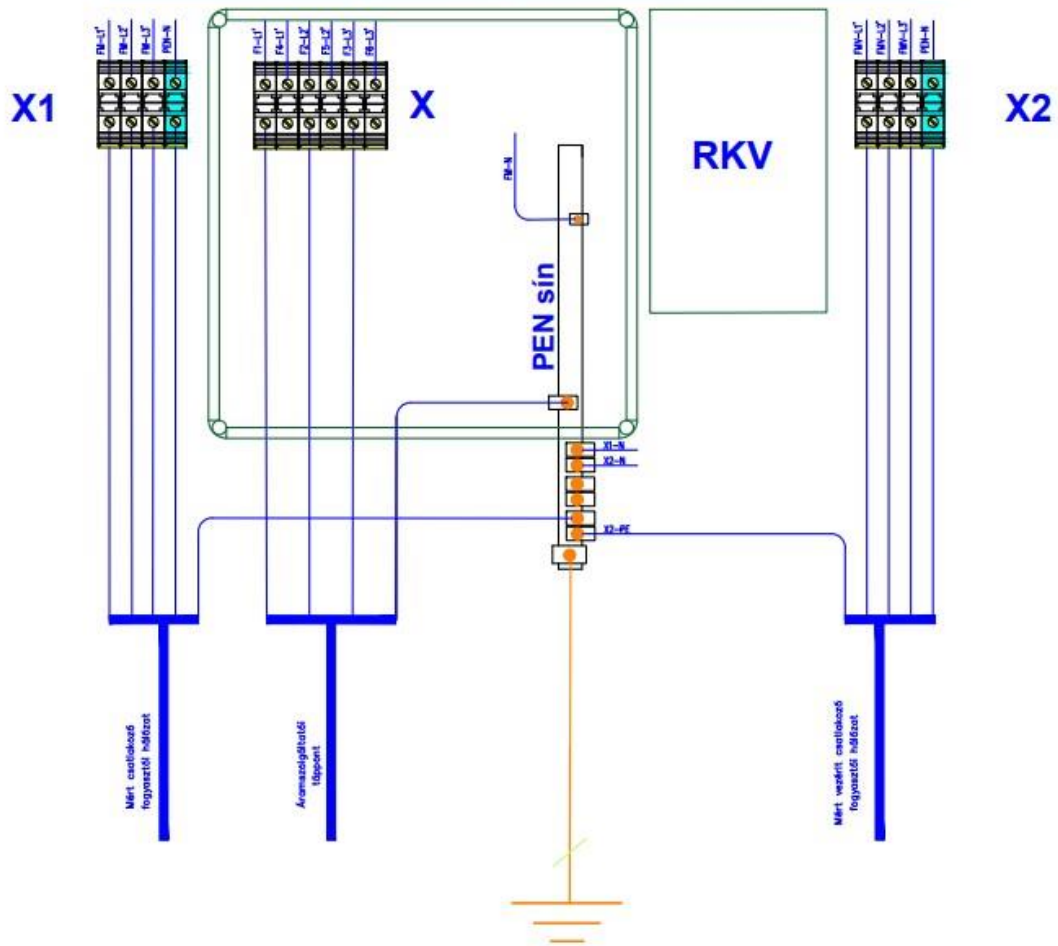
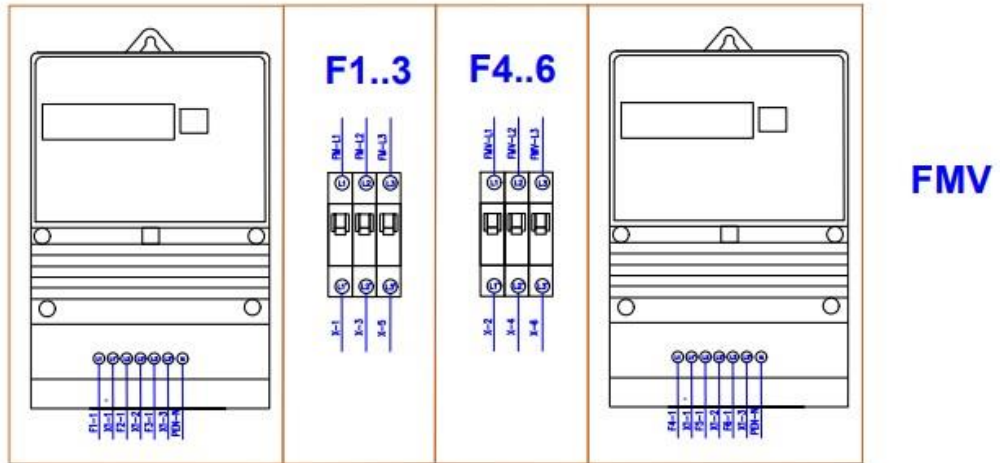

# WIRING DIAGRAM



## KAPCSOLÁSI RAJZ

$I_z = 10\text{kA}$

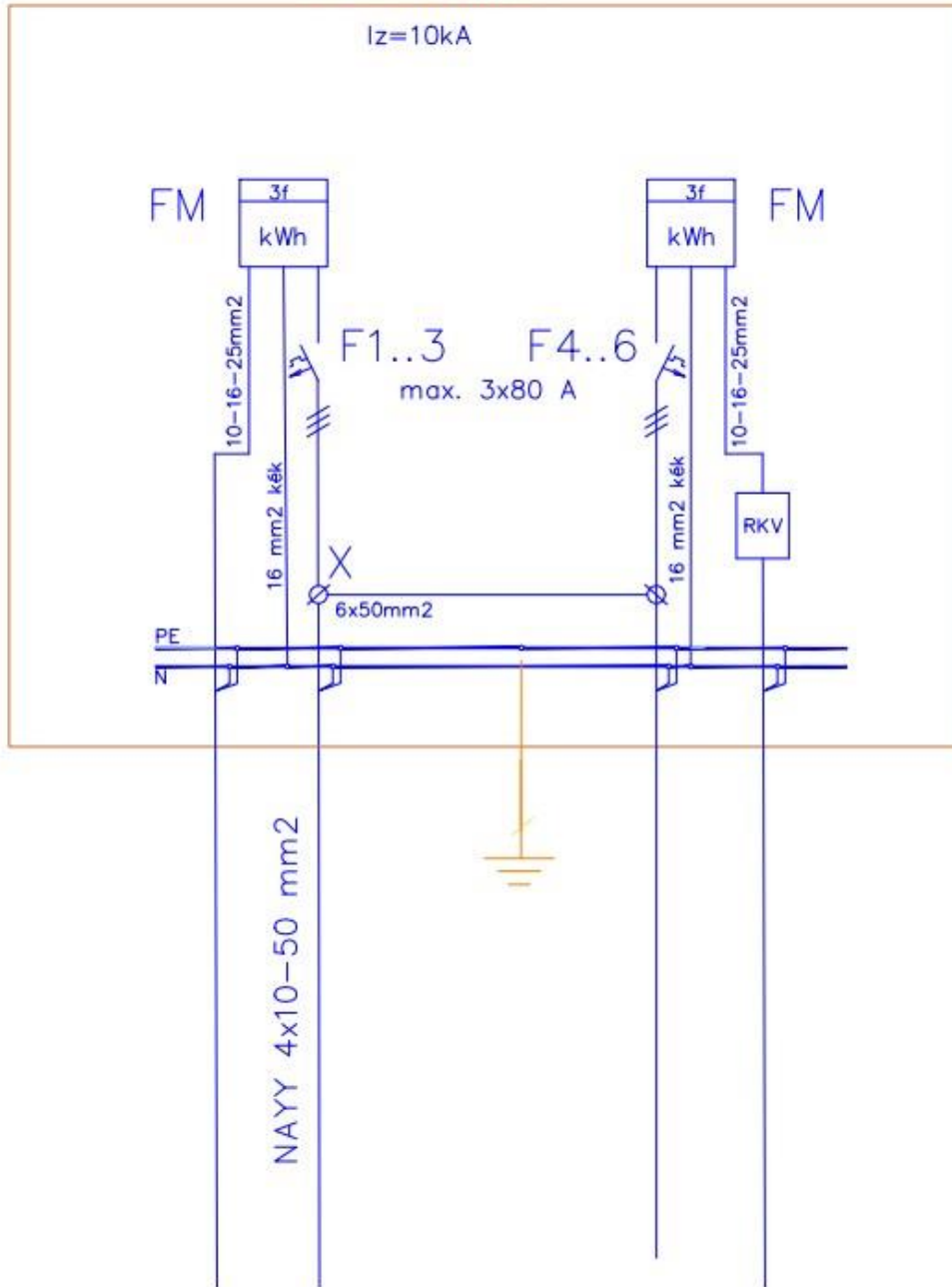

FESZÜLTÉSÉG. 3x400/230V AC

ÉRINTÉSVÉDELEM: TN



## TECHNICAL DATA SHEET

### **GENERAL STRUCTURAL DESIGN**

	IN	OUT
HEIHGT [mm]	1700	1720
WIDTH [mm]	560	583
DEPTH [mm]	270	277

Connection method: Ground cable (F)

Cabinet material: fiberglass polyethylene

Total weight: 25 kg

Color: RAL 7030

Built-in devices PVT 3030, CSP122209,CSP 081908, WDU 50mm<sup>2</sup>

### **ELECTRICAL DATA**

Rated voltage: 3 x 230 V / 400 V

Rated frequency: 50 Hz

Rated current: M63.80A (Mindennapszaki 3 x 63A-ig és 3 x 80A)

M63.80A (Vezérelt) 3 x 63A-ig és 3 x 80A

Short-circuit current: 6 kA

Type and size of wires that can be connected: Cable, "M" wire, 50mm<sup>2</sup>

Position of wires to be connected: from below

Touch protection method: covered

Contact protection class: II. class

## ***PROTECTION AGAINST ENVIROMENTAL AND MECHANICAL EFFECTS***

Protection against environmental and mechanical effects

Design: Outdoor (K)

Ambient temperature: min.-20 ° C, max. + 50 ° C / min.

Humidity conditions: relative humidity max. 50% / + 40 ° C

UV resistance: Outdoor, MSZ EN 61439-1 10.2.4. according to which no test is required

Protection: IP rating IP 44

Impact resistance: IK grade IK10

Corrosion resistance (for metal enclosures): Complies with a "grade" test

## INSTALLATION INSTRUCTION

### ***EQUIPMENT INSTALLATION***

When choosing the installation location of the meter cabinets, take into account:

- It must be possible to approach both sides of the cabinet.
- It is advisable to provide traffic routes in addition to building walls or landmarks.
- It is advisable to select a part of the plot boundary that is protected from damage.
- The installation location of the cabinet must not be a "catchment".
- The assembled cabinet (with plinth) (85x40) cm must be placed in a 60 cm deep pit and temporarily fixed. (The "plinth depth" is 50-60 cm!) The "Installation height" (ground level) is marked on the cabinet! If required by the soil conditions, the plinth must be bolted to concrete slabs and the cabinet installed.
- After removing the door, the front cover plates of the cabinet and plinth under the door must be screwed off to remove and secure the cables.
- A contact earth must be connected to the connection terminal of the cabinet for connecting the earth conductor (lower end of the PEN rail). As a technically suitable solution, it is most expedient to "return" the earth conductor from the earthing system of the electricity-powered building on the same route as the cable used as the measured main line. For this purpose, a corrosion-resistant (galvanized) round steel with a cross-section of at least 100 mm<sup>2</sup> is recommended. If the length of this return exceeds 3-4 meters, it is advisable to install a suitable earthing probe in the cabinet on its own.
- The relevant standards and general regulations of the power supply providers apply to the laying and installation of the connecting cables. Markings must be clearly provided on the associated cables.
- After completing the cable installation work, the front covers must be replaced in reverse order, the door can be refitted by snapping on the pins.
- Then, using the excavated soil, the final, stable fixation must be achieved by compacting it in layers, while checking the setting in both directions with a spirit level. It is recommended to use dry sand or moisture trap granules to reduce soil evaporation.
- The material of the cabinet withstands the thermal and chemical effects of asphaltting, so asphaltting the environment is not a problem. In this case, however, a slight slope must be created outwards from the cabinet to prevent rain from accumulating at the base of the cabinet.
- The cover plates under the cabinet door can be unscrewed with screws, so that the subsequent cable connection can be easily solved.

### ***MAKING CABLE CONNECTIONS***

The relevant standards and general regulations of the power supply providers apply to the laying and installation of the connecting cables. Markings must be clearly provided on the associated cables.

The immeasurable supply, the cable inserted into the 300x300 junction box via a gland, must be connected to 50mm<sup>2</sup> terminals. Outgoing measured cables can be connected to 50mm<sup>2</sup> terminals under cover. Grounding must be routed from the PEN rail if 5-wire.

## **INSTALLATION AND FIXING OF DEVICES**

The immeasurable supply, the cable inserted into the 300x300 junction box via a gland, must be connected to 50mm<sup>2</sup> mains terminals. Wires numbered from the terminal block for circuit breakers, which can be snapped onto the top-hat rail in the CSP 081908 junction box. Outgoing measured cables can be connected to 50mm<sup>2</sup> terminals under cover.<sup>5</sup> For a wired system, the ground must be routed from the PEN rail.

## **PREVENTION AND REDUCTION OF CONDENSATION AND HEATING**

When choosing the installation location of the meter cabinets, take into account:

- It must be possible to approach both sides of the cabinet.
- It is advisable to provide traffic routes in addition to building walls or landmarks.
- It is advisable to select a part of the plot boundary that is protected from damage.
- The installation location of the cabinet must not be a "catchment".

It is recommended to use dry sand or moisture trap granules to reduce soil evaporation

## **COMMISSIONING THE DEVICE**

- The assembled cabinet (with plinth) (85x40) cm must be placed in a 60 cm deep pit and temporarily fixed. (The "plinth depth" is 50-60 cm!) The "Installation height" (ground level) is marked on the cabinet! If required by the soil conditions, the plinth must be bolted to concrete slabs and the cabinet installed.
- After removing the door, the front cover plates of the cabinet and plinth under the door must be screwed off to remove and secure the cables.
- A contact earth must be connected to the connection terminal of the cabinet for connecting the earth conductor (lower end of the PEN rail). As a technically suitable solution, it is most expedient to "return" the earth conductor from the earthing system of the electricity-powered building on the same route as the cable used as the measured main line. For this purpose, a corrosion-resistant (galvanized) round steel with a cross-section of at least 100 mm<sup>2</sup> is recommended. If the length of this return exceeds 3-4 meters, it is advisable to install a suitable earthing probe in the cabinet on its own. The relevant standards and general regulations of the power suppliers apply to the laying and installation of the connecting cables. Markings must be clearly provided on the associated cables.
- After completing the cable installation work, the front covers must be replaced in reverse order, the door can be refitted by snapping on the pins.
- Then, using the excavated soil, the final, stable fixation must be achieved by compacting it in layers, while checking the setting in both directions with a spirit level. It is recommended to use dry sand or moisture trap granules to reduce soil evaporation.
- The final sealing is carried out by the specialists of the power supply on the two junction boxes at the consumption meter and on the opening plate.

## **CHECKLIST TO SUPPRT INSTALLATION AND VERIFICATION**

When choosing the installation location of the meter cabinets, take into account:

- It must be possible to approach both sides of the cabinet.
- It is advisable to provide traffic routes in addition to building walls or landmarks.
- It is advisable to select a part of the plot boundary that is protected from damage.
- The installation location of the cabinet must not be a "catchment".
- It is recommended to use dry sand or moisture trap granules to reduce soil evaporatio

## **HANDLING AND MAINTENANCE**

### **GENERAL INFORMATION**



INSTALLATION  
TECHNOLOGY INSTR

### ***Opening, closing and operating the cabinet***

The lock cover on the cabinet is pulled to the side and the key in the half-cylinder is turned to the right. using the blanket, pull the locking tongue out towards you. Turn to the right to release the 3-point locking tongue. We pull the door towards us. Closing is the other way around.

### **MAINTENANCE**

1. When the equipment is put into operation, fuse-links of the size and value specified in the circuit-breaker fuses must be installed.
2. The rails in the equipment, the devices, the installation materials and the plastic cabinet itself do not require any special maintenance from the operator.

#### **General tasks to be repeated annually during normal operation:**

1. The equipment must be dusted inside and out. Particular attention should be paid to cleaning the busbars for reasons of cooling and insulation. It is also important to clean the connection terminals and terminals of the devices.
2. The correctness of the screw connections must be checked and any loose connections must be tightened. The amount of tensile strength is indicated in Nm on most items, and the catalogs available contain the required values. In other cases, retrofitting must be carried out as usual in installation practice. At the heating points resulting from loose joints, in addition to retraction, the mechanical strength of the joints and the correctness of the insulation must be checked. If necessary, defective batteries must be replaced immediately.

#### **What to do in the event of a short circuit trip:**

Insurance deposits may only be replaced with deposits of the same value as the original. The insertion of a higher value insert is only permitted after checking the load capacity of the elements in the circuit. The use of bridged, horseshoe inserts is prohibited!

**During all maintenance operations, the applicable contact protection and operating laws, regulations and instructions must be observed and acted upon!**

#### **DATA TABLE**

<b>DISTRIBUTOR:</b>	Közvillszer Kft	
<b>ADRESSE</b>	1183 Budapest Gyömrői út 118.	
<b>phone:</b>	+36-1 205-6085	
<b>E-mail:</b>	kereskedelem@kozvillszer.hu	
<b>webpage:</b>	<a href="http://www.kozvillszer.hu">www.kozvillszer.hu</a>	

#### **KOZV M172 CS**

- *LIST OS STANDARD USE*
- MSZ EN 61439-1
- MSZ EN 61439-1 :2012

#### **DOCUMENTATION**

#### **TYPE OF CONSUMPTION**

- complete wiring, ready for installation with a load capacity of 80 A,
- 10mm<sup>2</sup> wire for 32A use
- 16mm<sup>2</sup> wire for 63A use
- To use 80A, a 25mm<sup>2</sup> cross-section wire must be ordered
- TS-35 type mounting rail,
- PVT3030 Striker 150X300, 300 \* 300 binding box
- CSP 081908 Striker junction boks
- SK 1-3 50 mm<sup>2</sup> terminal block for connecting cable cores
- WDU 50 Terminal block for connecting outgoing cable cores

#### **MAIN CIRCUIT WIRING**

- Type: H07VK cable with 18 mm ferrule
- Conductive material: Cu (copper, elemental fiber),
- Cross section: 10 mm<sup>2</sup> Suitable for 32 A loads
- Cross section: 16 mm<sup>2</sup> Suitable for 63 A loads
- Cross section: 25 mm<sup>2</sup> suitable for 80A loads
- Rated voltage: 400V
- Pressed wire end sleeve according to the cross section of the cable and the dimensions of the receiving terminal
- Clear marking of the same shape, material, non-removable, durable at the ends of the wires